



KETRA

X96

KETRA CONTROLLER

Installation Guide



Models

HW-X96-X-J1

CM-X96-X-J1

WARNING

Shock Hazard. May result in Serious Injury or Death. Turn power OFF at circuit breaker or remove fuse.



This device complies with part 15 of the FCC Rules and Industry Canada license-exempt RSS standard (s). Operation is subject to the following two conditions:

- (1) This device may not cause harmful interference
- (2) This device must accept any interference received, including interference that may cause undesired operation.

277 V~ NOTE: This equipment has been tested at 277 V~ and found to comply with the limits for a Class A digital device, pursuant to part 15 of the FCC Rules. These limits are designed to provide reasonable protection against harmful interference when the equipment is operated in a commercial environment. This equipment generates, uses, and can radiate radio frequency energy and, if not installed and used in accordance with the instruction manual, may cause harmful interference to radio communications. Operation of this equipment in a residential area is likely to cause harmful interference in which case the user will be required to correct the interference at their own expense.

120 V~ NOTE: This equipment has been tested at 120 V~ and found to comply with the limits for a Class B digital device, pursuant to part 15 of the FCC Rules. These limits are designed to provide reasonable protection against harmful interference in a residential installation. This equipment generates, uses and can radiate radio frequency energy and, if not installed and used in accordance with the instructions, may cause harmful interference to radio communications. However, there is no guarantee that interference will not occur in a particular installation. If this equipment does cause harmful interference to radio or television reception, which can be determined by turning the equipment off and on, the user is encouraged to try to correct the interference by one or more of the following measures:

- Reorient or relocate the receiving antenna.
- Increase the separation between the equipment and receiver.
- Connect the equipment into an outlet on a circuit different from that to which the receiver is connected.
- Consult the dealer or an experienced radio/TV technician for help.

Included Components

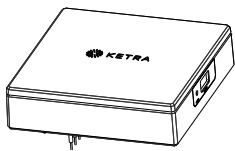

(1) X96 Ketra Controller

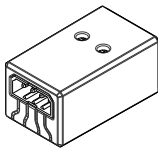

(1) Type A Adapter





(2) Mounting Screws

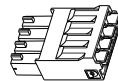

(3) Wire Nuts



(1) X96 Ketra Controller Connector

<p>Dimensions: Length: 5 in (127 mm) Width: 5 in (127 mm) Height: 1.3 in (33 mm)</p>	<p>Used to connect 4-wire cable to input of LSO luminaire. See install guide P/N 3662562 for more information.</p> <p>Dimensions: Length: 1.2 in (30.5 mm) Width: 0.7 in (17.8 mm) Height: 0.6 in (15.25 mm)</p> <p>Wire Gauge: Signal Connections: 18–24 AWG (0.75–0.25 mm²) Power Connections: 16–20 AWG (1.0–0.5 mm²)</p> <p>Strip Length:  5/16 in (8 mm)</p>	<p>Used to mount X96 Ketra controller to 4 in x 4 in (101.6 mm x 101.6 mm) U.S. junction box.</p> <p>8 – 32 X 1.5 in #2 Phillips Drive Machine Screw</p>	<p>Suitable for copper wire only. For aluminum wire consult an electrician.</p> <p>Listed as pressure type wire connector on the following solid and / or stranded combinations.</p> <ul style="list-style-type: none"> • (1-3) 12 AWG (4.0 mm²) • (2-3) 14 AWG (2.5 mm²) • (1-2) 12 AWG (4.0 mm²) and (1) 14 AWG (2.5 mm²) • (1-2) 12 AWG (4.0 mm²) and (1) 16 AWG (1.5 mm²) • (1-2) 14 AWG (2.5 mm²) and (1) 16 AWG (1.5 mm²) • (1-2) 12 AWG (4.0 mm²) and (1) 18 AWG (1.0 mm²) • (1-2) 14 AWG (2.5 mm²) and (1) 18 AWG (1.0 mm²) <p>Strip Length:  7/16 in (11 mm) for 18 AWG and 16 AWG (1.0 mm² and 1.5mm²) wires 3/8 in (10 mm) for 14 AWG and 12 AWG (2.5 mm² and 4.0 mm²) wires</p>	<p>Used to connect 4-wire cable to output of X96 Ketra controller</p> <p>Plugged in Dimensions: Length: 0.53 in (13 mm) Width: 0.6 in (15 mm) Height: 0.31 in (8 mm)</p> <p>Wire Gauge: 24 AWG to 16 AWG (0.25 mm² to 1.5 mm²)</p> <p>Strip Length:  3/8 in (10 mm)</p>
---	---	--	--	--

Electrical Specifications

Output

21 V $\overline{=}$ Max 96 W to power LS0 luminaire
3.3 V $\overline{=}$ control signal to control light level
and color temperature of LS0 luminaire

Input

120/277 V \sim 60 Hz Max 110 W
Current 0.92 A/0.40 A

Pre-Installation

Important Notes: *Please read before installing.*

- For installation by a qualified electrician in accordance with all local and national electric codes.
- Turn power off before installing.
- Damage to this product caused by wiring with power on voids the warranty.
- Use copper conductors only.
- For indoor use only.
- For use only with LS0 luminaires.
- DO NOT install if the product has any visible damage.
- If moisture or condensation is evident, allow the product to dry completely before installation.
- Operate between 32 °F and 104 °F (0°C and 40°C) ambient.
- 0% to 90% humidity, non-condensing.

Find a suitable mounting location:

- Mount within wiring range of the LS0 luminaire. A total of 50 ft (15 m) of cable can be used, from the X96 Ketra controller to the last LS0 luminaire, including cabling in between luminaire segments.
- The X96 Ketra controller, a Clear Connect Type X device, must be mounted within 71 ft (21.5 m) of its assigned gateway. The X96 must have at least two non-battery-powered Type X devices with 25 ft (7.5 m). Within a subnet, groups or clusters of Type X devices must not be separated by greater than 25 ft (7.5 m). The gateway and the Type X devices assigned to it must be on the same floor.
- Mount a minimum of 3 ft (1.0 m) away from interference sources in the 2.4 GHz band, including but not limited to microwaves, wireless access points, hotspots, baby monitors, thermostats, and voice recognizing control devices.
- Do not install the controller inside a third-party enclosure. Performance of Type X devices can severely degrade if installed inside metal enclosures.
- For additional guidelines regarding Type X devices, refer to Lutron Application Note #745 (P/N 048745) at www.lutron.com
- A minimum of 2 in (51 mm) of free space is required all around the controller. See Figure 1.
- Mount the controller in a position where it can be easily located and accessed if service or troubleshooting is necessary.
- Ensure that the reset button and output connector can be accessed. See Figure 2.
- Ensure there is sufficient space above the junction box to drive the mounting screws and attach the top cover.
- Ensure that the junction box is rotated to allow the output wiring on the controller to route towards the first LS0 luminaire.

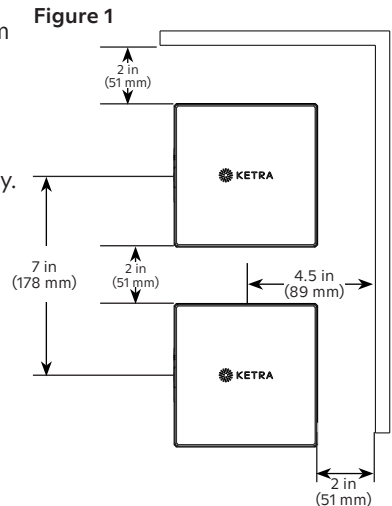

Installation

STEP 1

Input Wiring (shown in Figure 2)

NOTE: Branch wiring is permitted.

1. Bring mains supply wires through 4 in x 4 in (101.6 mm x 101.6 mm) U.S. junction box.
2. Connect the green ground wire on the controller to the green or bare ground wire in the junction box using the supplied wire nuts.
3. Connect the black wire on the controller to the Line/Hot wire in the junction box using the supplied wire nuts.
4. Connect the white wire on the controller to the Neutral wire in the junction box using the supplied wire nuts.

Figure 2

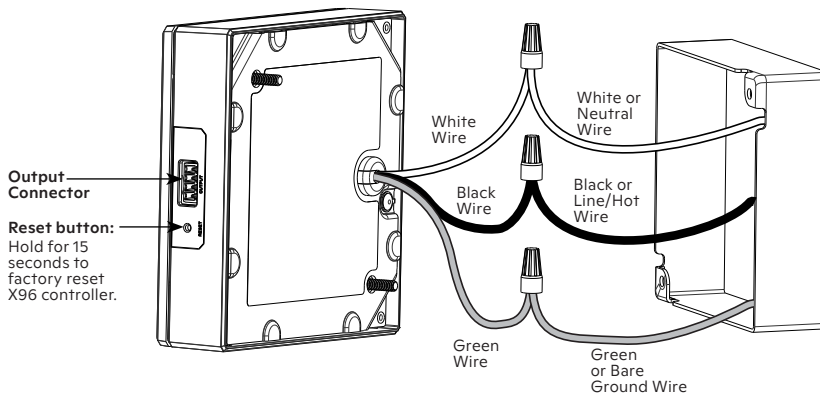

INSTALLATION

STEP 2

Mounting *(shown in Figure 3)*

1. Remove top cover to access the mounting holes.
2. Mount the X96 Ketra Controller as shown in Figure 3.
3. Snap top cover back onto controller.

Figure 3

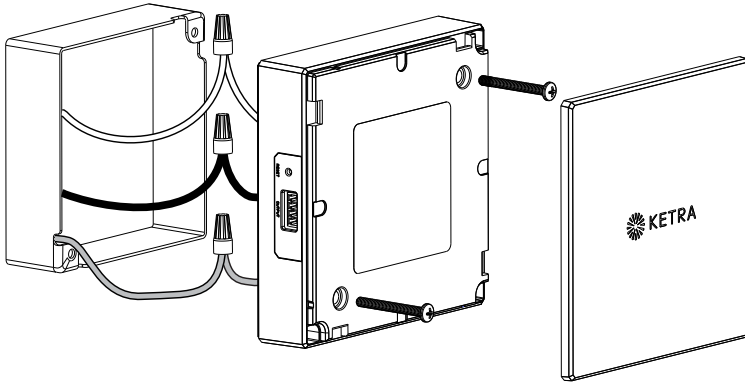

INSTALLATION

STEP 3

Output Wiring *(shown in Figure 4)*

1. Strip the 4 wires in the 4-wire cable (QS-CBL(P)-M or eqv.) to 3/8 in (10 mm).
2. Push wires into provided plug, positions per diagram below.
 - Pos 1: Red (16 AWG [1.5 mm²])
 - Pos 2: Purple (22 AWG [0.5 mm²])
 - Pos 3: White (22 AWG [0.5 mm²])
 - Pos 4: Black (16 AWG [1.5 mm²])
3. If needed, push release levers on output connector to remove wires.

Figure 4

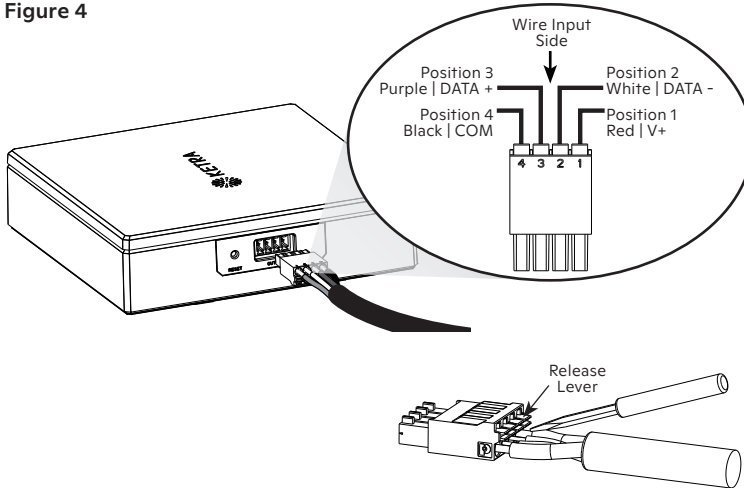

Troubleshooting

Ketra's LS0 Linear should power on to a default white state. If it powers on to some other color, that means there's a problem in the installation conditions. See the table below for the meaning of each color.

TROUBLESHOOTING TABLE

Color	Condition	Correction
Red or OFF	Voltage from X96 Controller is too low	Ensure that the controller is the Ketra X96 controller. Check to see if total cable length exceeds 50 ft (15 m), reduce to 50 ft (15 m) of cable from X96 to last LS0 segment. Ensure that power conductors are 16 AWG or 12 AWG (1.5 mm ² or 3.5 mm ²) wires, or use the QSH-CBL(P)-M-500 or QSH-CBL(P)-L-500. Ensure that length of LS0 linear does not exceed maximum length requirements i.e., 15 ft (4.5 m) for high output and 24 ft (7.3 m) for long run. Verify power connections (red and black on QSH-CBL-M-500) are wired correctly on the X96 controller and each luminaire adapter
Magenta	LS0 is installed backwards	Disconnect power, check wiring at adapters and follow wiring directions above, or disconnect luminaire and reverse direction
Blue	Missing or reversed communication signals	Verify communication (purple and white on QSH-CBL-M-500) are wired correctly on the X96 controller and each luminaire adapter
Green or OFF	Line voltage is too low	Line voltage must be nominally 120 or 277 V~ 60 Hz for X96
Yellow	Number of luminaires exceeds length limits. Limit for 15 ft (4.5 m) for high output and diffused lens type and 24 ft (7.3 m) for long run lens type.	Remove excess luminaires and power cycle the X96 controller

Warranty & Tech Support

Limited warranty terms can be found at:

www.ketra.com/warranty

For questions and technical support, please contact:

(844) 588-6445

ketrasupport@lutron.com

Ketra and the Ketra logo are trademarks or registered trademarks of Lutron Electronics Co., Inc. in the US and/or other countries.



6231 E. Stassney Ln.
Bldg. 13, Suite 400
Austin, TX 78744

www.ketra.com

512.872.4349

P/N 3662581 Rev A
© 2021 Lutron Electronics Co., Inc.

