



# N4

CONDUIT-MOUNTED HUB

Installation Guide



## Model

N4-1-CND-BK - Ketra N4 Conduit-Mounted Hub

# Warning

---

Risk of electric shock. Use in dry locations only.

This device complies with Part 15 of the FCC Rules. Operation is subject to the following two conditions: (1) this device may not cause harmful interference, and (2) this device must accept any interference received, including interference that may cause undesired operation.

Maintain at least 6 feet of spacing between any KetraNet Mesh product and Wi-Fi routers and access points.



Note: This equipment has been tested and found to comply with the limits for a Class B digital device, pursuant to part 15 of the FCC Rules. These limits are designed to provide reasonable protection against harmful interference in a residential installation. This equipment generates, uses and can radiate radio frequency energy and, if not installed and used in accordance with the instructions, may cause harmful interference to radio communications. However, there is no guarantee that interference will not occur in a particular installation. If this equipment does cause harmful interference to radio or television reception, which can be determined by turning the equipment off and on, the user is encouraged to try to correct the interference by one or more of the following measures:

- Reorient or relocate the receiving antenna.
- Increase the separation between the equipment and receiver.
- Connect the equipment into an outlet on a circuit different from that to which the receiver is connected.
- Consult the dealer or an experienced radio/TV technician for help

This device contains licence-exempt transmitter(s)/receiver(s) that comply with Innovation, Science and Economic Development Canada's licence-exempt RSS(s). Operation is subject to the following two conditions:

- This device may not cause interference.
- This device must accept any interference, including interference that may cause undesired operation of the device.

# Contents

---

	2
Product Overview	4
Explanation of Indicator Lights	5
Included Components/Specs	6
Specifications	6
Dimension Drawings	7
Wiring Diagrams	8
Pre-Installation	9
N4 Placement	9
Network Configuration	9
Installation	10
Apply Power to the Hub	10
Connect the Hub to the LAN (Local Area Network)	10
Additional Tasks	12
Controlling with Design Studio	12
Controlling with the Ketra Mobile App	12
Warranty & Tech Support	13

# Product Overview

---

Ketra's N4 Hub forms a bridge between Ketra products and Ketra digital interfaces such as Design Studio, mobile app, and API commands.

With multiple N4s, a user can integrate KNETs, allowing for seamless installations no matter how large. Using an Internet connection, the Hub can connect to Ketra's cloud servers to enable backup and remote maintenance functions.

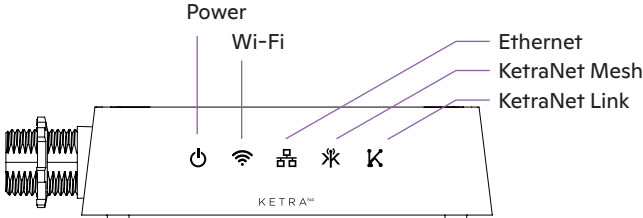

fig. 1

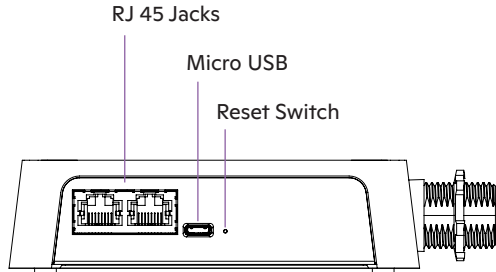







fig. 2

*continued on next page*

## Explanation of Indicator Lights

The N4 indicates its status using the lights on the front.

Indicator Light Behavior		
Symbol	Name	Expected Behavior
	Power	<ul style="list-style-type: none"> <li>Red briefly at startup</li> <li>White at all other times while N4 is on</li> </ul>
	Wi-Fi	<ul style="list-style-type: none"> <li>For future use</li> </ul>
	Ethernet	<ul style="list-style-type: none"> <li>Red briefly at connection to LAN (while N4 waits for an IP address)</li> <li>White at all other times while network connection active</li> <li>Dark if no LAN connection is detected</li> <li>Blinking red if N4 detects a network wiring loopback</li> </ul>
	KetraNet Mesh	<ul style="list-style-type: none"> <li>Blinks red when a "remote access" message is sent or received</li> <li>Solid red when the hub is configured for remote access, but the hub cannot connect to the remote access server</li> </ul>
	KetraNet Link	<ul style="list-style-type: none"> <li>Blinking white when a message is sent or received over KetraNet Link (wired communication with other Ketra devices)</li> <li>Red when no Internet connection is detected</li> <li>Dark at all other times</li> </ul>

# Included Components/Specs

---

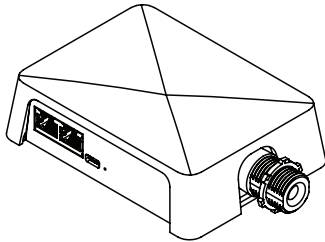

(1) N4 Conduit-Mounted Hub



(1) Threaded Ring

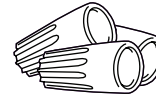

(3) Wire Nuts

## Specifications

### Environmental

---

Operating Temperature	-20° to 40°C
Storage Temperature	-20° to 80 °C
Humidity	0 - 95%, Non-condensing
Certification	UL, cUL, FCC Class B, RoHS
Location	UL Damp Location, IP20

### Mechanical

---

Weight	15 oz (0.43 kg)
Housing Material	Polymer

### Power

---

Voltage	120 V $\text{\textcircled{~}}$
Power Consumption	5W
Current	0.041 A at 120 V $\text{\textcircled{~}}$

### Enclosure & Connections

---

Connections (Class 1)	
AC Power In	6 in. (152.4 mm) 18 AWG Flying Leads
Data Connections	
Connectivity Technology	Wireless, Wired
Data Link Protocol	Ethernet, Fast Ethernet, IEEE 802.11b, IEEE 802.11g
KetraNet Mesh™ Wireless	
USB Port	1 - Micro-B USB console port, for firmware updates

# Dimension Drawings

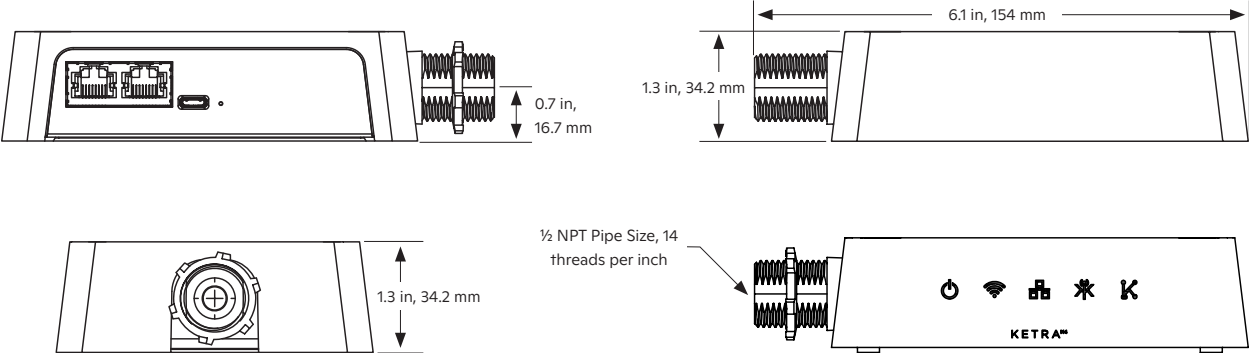

fig. 3

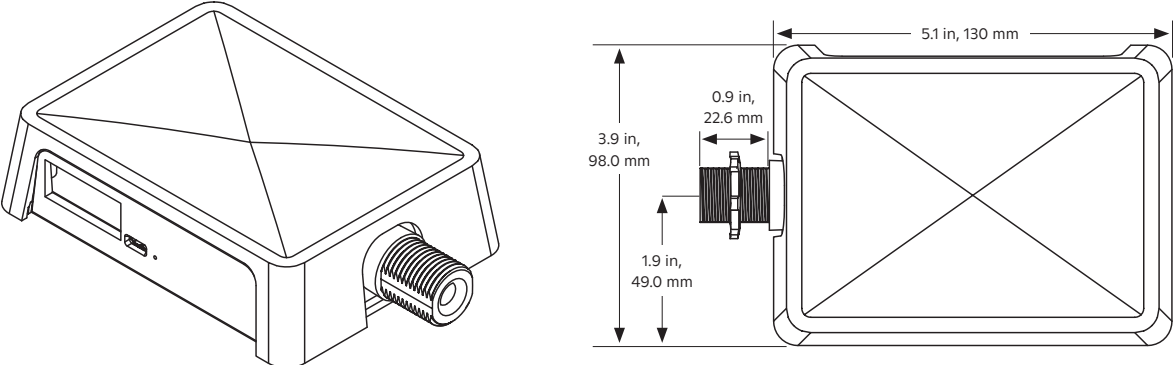
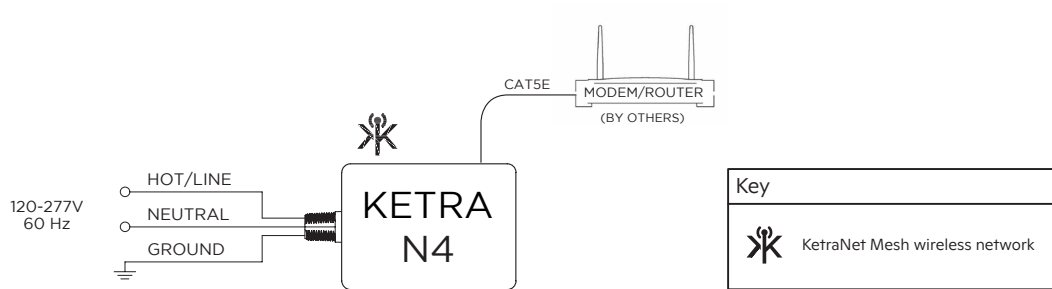

fig. 4

# Wiring Diagrams



## Example Installation Layout

**KNet:** N4 + 49 Ketra Wireless Devices

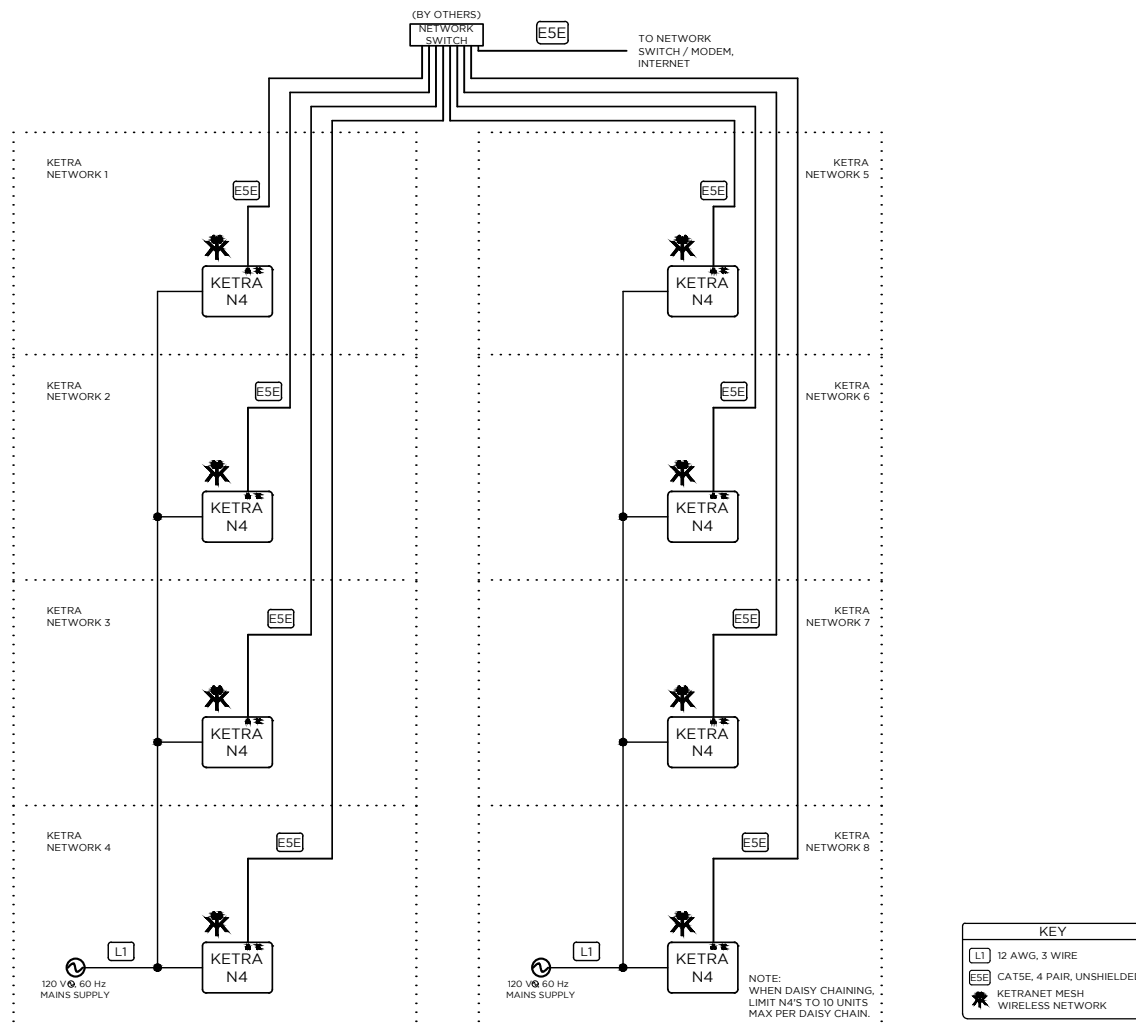



# Pre-Installation

---

## N4 Placement

For ideal KetraNet Mesh wireless performance, position the N4 according to these guidelines:

- Keep within range: Place the N4 within 50 ft (15.24 m) of at least one of the devices it will control. Ideally, place as close as possible to all devices it will control.
- Avoid obstructions: Avoid having metal obstructions or walls between the N4 and the nearest device it will control.
- Avoid metal enclosures.
- Separate from Wi-Fi devices: Maintain at least 6 ft (1.83 m) of spacing between any KetraNet Mesh product and Wi-Fi routers and access points.

The N4 is UL Damp Location-listed.

The N4 has a suggested clearance of 4 in (101.6 mm) to ensure visibility of indicator lights and access to all ports (see fig. 5).

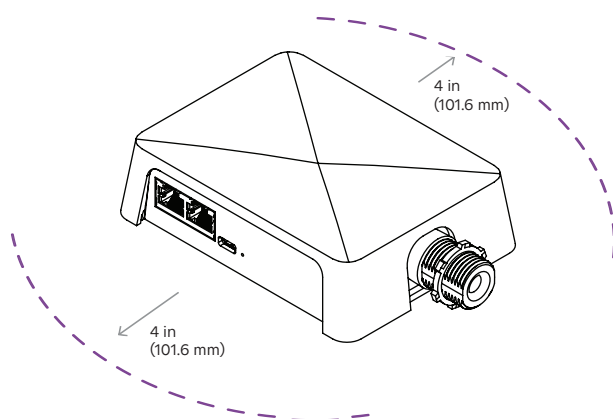

fig. 5

## Network Configuration

The modem or router to which the N4 is connected must include a DHCP server from which the N4 can obtain an IPv4 address. (For the vast majority of modems and routers, this is the default.)

All N4s that will be part of an installation together must be on the same LAN (Local Area Network) subnet.

# Installation

---

## STEP 1

### Apply Power to the Hub

1. Remove a half-inch knockout from the junction box.
2. Mount the N4 to the junction box. Fit the N4's connector into the opening created in step 1. Secure the N4 by threading the provided threaded ring onto the mount.

#### Notes:

- Orientation: The N4's serial number (on the bottom) should face the access point. The serial number may be necessary for commissioning and servicing.
  - Clearance: Remove nearby obstructions. This will ensure the visibility of the indicator lights as well as access to all ports.
3. Splice the N4 into building power. Using the provided wire nuts, attach each lead wire to the corresponding conductor. All connections should be made inside the junction box.

*Black: Line*

*White: Neutral*

*Green: Ground*

**Note:** Once power is connected, the N4's power indicator light will come on. It will be red while the N4 boots up; afterward, it will turn white.

## STEP 2

### Connect the Hub to the LAN (Local Area Network)

Once a connection is detected, the N4's Ethernet indicator, , will come on white.

## DIRECT CONNECTION TO MODEM OR ROUTER

*continued on next page*

## INSTALLATION

- Use a CAT5 or equivalent Ethernet cable

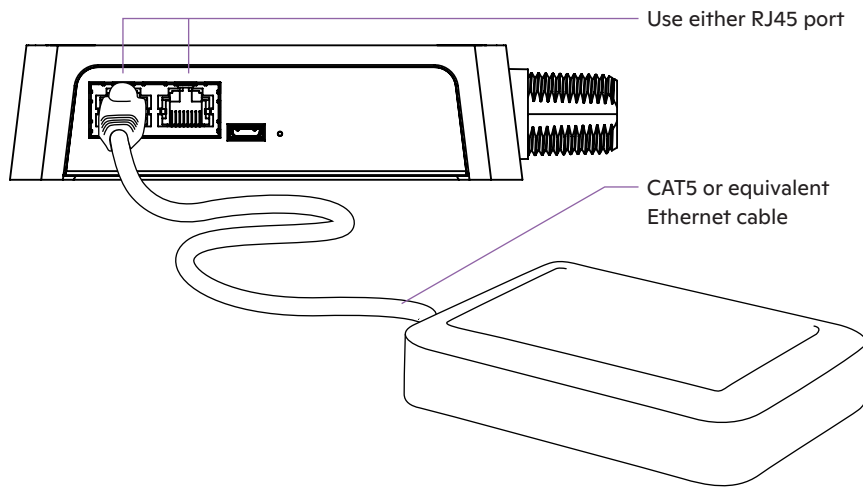

fig. 6

- Cable can be no more than 328 ft (100 m)

# Additional Tasks

---

## Controlling with Design Studio

For simple instructions on establishing an N4 installation in Design Studio, refer to the N4 edition of our Design Studio Quick Start Guide.

For more advanced instructions on establishing an N4 installation in Design Studio, refer to the following portions of the Design Studio User Manual:

- Getting Started > Installation Management > Creating an Installation
- Operating an Installation > Organization

If you are unable to discover your N4s in Design Studio, confirm one of the following is true:

**Option 1:**

- Your computer is on the same subnet as all N4's

**OR**

**Option 2:**

- Your computer is on the same network as the N4's
- All N4's are on the same subnet
- The N4's have internet access
- Your computer has internet access

## Controlling with the Ketra Mobile App

For instructions on using an N4 with the Ketra app, refer to our Mobile App Manual.

If you are unable to discover your N4s in the Ketra app, confirm one of the following is true:

**Option 1:**

- Your mobile device is on the same subnet as all N4's

**OR**

**Option 2:**

- Your mobile device is on the same network as the N4's
- All N4's are on the same subnet
- The N4's have internet access
- Your mobile device has internet access

# Warranty & Tech Support

---

Limited warranty terms can be found at:

[www.ketra.com/warranty](http://www.ketra.com/warranty)

For questions and technical support please contact:

**(844) 588-6445**

**[ketrasupport@lutron.com](mailto:ketrasupport@lutron.com)**

**Ketra and KetraNET are trademarks or registered trademarks of Lutron Ketra LLC, in the US and/ or other countries.**



6231 E. Stassney Ln.  
Bldg. 13, Suite 400  
Austin, TX 78744

[ketra.com](http://ketra.com)  
512.872.4349