

G2 High Output Linear Accent

The Ketra Difference:

High Def Palette—covers a wide range of 16.7 million colors, including pastels, saturated colors and high CRI whites spanning from 1,400K to 10,000K.

Dynamic Spectrum—precisely tunes the amount of energy across the visible spectrum to produce Natural Light, Natural Dimming and Vibrancy.

TruBeam—produces uniform color across any available beam angle.

Color Lock—maintains your desired color point at a one-step MacAdam Ellipse across all Ketra product families and over each product’s lifetime.



ORDERING GUIDE

Please download this PDF to use the interactive drop down features of the ordering guide.

Product Line	G2	12	Lumens	System	Beam Angle	Region /Voltage	A	WH
	Model	Length					Interface	Housing Color

Order code: _____

Product Line	Code	System	Code	Region / Voltage	Code
Commercial (Athena compatible)	CM-	KetraNet/CCX ¹	BT	North America, 120 V~ 60 Hz	11
Residential (HomeWorks compatible)	HW-	Beam Angle		North America, 277 V~ 60 Hz	12
		Graze (10° X 60°)	GR		
		Narrow Flood (30° X 45°)	NFL		
		Flood (60° X 60°)	FL	Interface	
Model		Wide Flood (120° X 120°)	WFL	Leader Cable	A
G-Series 12 in Linear Accent	G2			Housing Color	
				White	WH
Length					
1 foot (12 inch, 30.48 cm)	12				
Lumens					
1000	10				
700	07				
400	04				

¹ CCX stands for Clear Connect-Type X.



G2 HIGH OUTPUT LINEAR ACCENT

P/N 3662375 Rev F

Specifications are subject to change without notice

SPECIFICATIONS¹

Optical Performance

Lumen Output ²	G2.10 1000 lm/ft, G2.07 700 lm/ft, G2.04 400 lm/ft
CRI (Ra) ³	>90
Lumen Maintenance ³	50,000 hours to L70 @ 25 °C Ambient
Color Point Maintenance ³	One-step MacAdam Ellipse over product lifetime
Beam Angles	10×60° 30×45° 60×60° 120×120°
Dimming Range ¹	0.1-100%

Environmental

Ambient Operating Temperature	-20 - 50 °C
Storage Temperature	-20 - 80 °C
Humidity	0 - 95%, Non-condensing
Certification	UL, cUL, RoHS
Location	UL Damp Location, IP20
Outdoor Use	Not for use in outdoor applications

Form Factor

Dimensions:

Beam Angle	Dim A	Dim B	Dim C
Wide Flood	12 in, 305 mm	2 in, 50.8 mm	2.5 in, 63.5 mm
Flood			2.5 in, 63.5 mm
Narrow Flood			2.65 in, 67 mm
Graze			3.1 in, 78.7 mm

Rotation **Infinite adjustment through 180°**

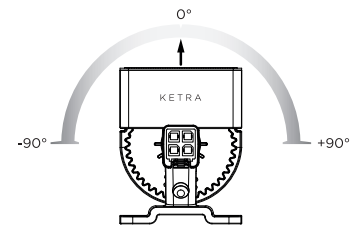
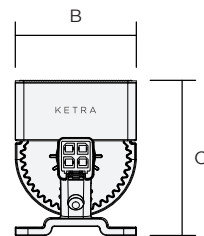
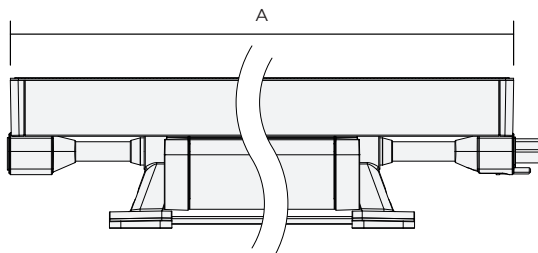

Mechanical

Weight (12 in, 304.8 mm)	1.35 lbs (600 g)
Housing Material	Powder Coated Aluminum, Polymer
Lens Material	Non-yellowing heat/UV stabilized PMMA

Electrical Performance

Power Consumption	120 V~	277 V~
	G2.10 17 W/ft TYP, G2.07 11.5 W/ft TYP, G2.04 8 W/ft TYP	G2.10 15.5 W/ft TYP, G2.07 11 W/ft TYP, G2.04 7.7 W/ft TYP
Power Factor	>0.9	>0.9
Current	120 V~	277 V~
	G2.10 0.14 A G2.07 0.10 A G2.04 0.07 A	G2.10 0.06 A G2.07 0.04 A G2.04 0.03 A
Efficacy	120 V~	277 V~
	G2.10 58.8 lm/W TYP, G2.07 60.9 lm/W TYP, G2.04 50 lm/W TYP	G2.10 64.5 lm/W TYP, G2.07 60.9 lm/W TYP, G2.04 51.9 lm/W TYP
Max. Qty of Fixtures Per N3	40	
Max Total Run Length, including cable, Per N3	100 ft (30.48 m)	
Input voltage	120 V~ 60 Hz, 277 V~ 60 Hz +/- 10%	
Total Harmonic Distortion (THD)	< 5%	

¹ All performance measurements taken with fixture stabilized at 25° C ambient, 100% power input, unless otherwise stated, within CCT range of 2700 - 5000 K.
² Lumen measurement complies with IES LM-79-08 testing procedures.
³ Lumen maintenance values calculated in accordance to TM-21 procedures based on LM-80 compliant measurement data.



KETRA

G2 HIGH OUTPUT LINEAR ACCENT

P/N 3662375 Rev F

Specifications are subject to change without notice

ACCESSORIES

Leader 50 ft, White (with Terminator)	UN-G2L6001CWH
Leader 50 ft, Black (with Terminator)	UN-G2L6001CBK
Leader 10 ft, White (with Terminator)	UN-G2L1201CWH
Leader 10 ft, Black (with Terminator)	UN-G2L1201CBK
Lead Out 10 ft, White	UN-G2LO1201CWH
Lead Out 10 ft, Black	UN-G2LO1201CBK
Jumper 1 ft, White	UN-G2J0121CWH
Jumper 1 ft, Black	UN-G2J0121CBK
Jumper 5 ft, White	UN-G2J0601CWH
Jumper 5 ft, Black	UN-G2J0601CBK
Jumper 10 ft, White	UN-G2J1201CWH
Jumper 10 ft, Black	UN-G2J1201CBK
Jumper 25 ft, White	UN-G2J3001CWH
Jumper 25 ft, Black	UN-G2J3001CBK
Terminator (Optional Replacement)	UN-G2TC
G2 Hex Louver, 45°, White (NFL, FL, WFL)	UN-G212HLST45WH
G2 Hex Louver, 45°, Black (NFL, FL, WFL)	UN-G212HLST45BK
G2 Hex Louver 45°, White (GRAZE)	UN-G212HLGR45WH
G2 Hex Louver 45°, Black (GRAZE)	UN-G212HLGR45BK
G2 Hex Louver 65°, White (NFL, FL, WFL)	UN-G212HLST65WH
G2 Hex Louver 65°, Black (NFL, FL, WFL)	UN-G212HLST65BK
G2 Hex Louver 65°, White (GRAZE)	UN-G212HLGR65WH
G2 Hex Louver 65°, Black (GRAZE)	UN-G212HLGR65BK
G2 Alignment Track	UN-G2TRKZP48

EXAMPLE WIRING DIAGRAM

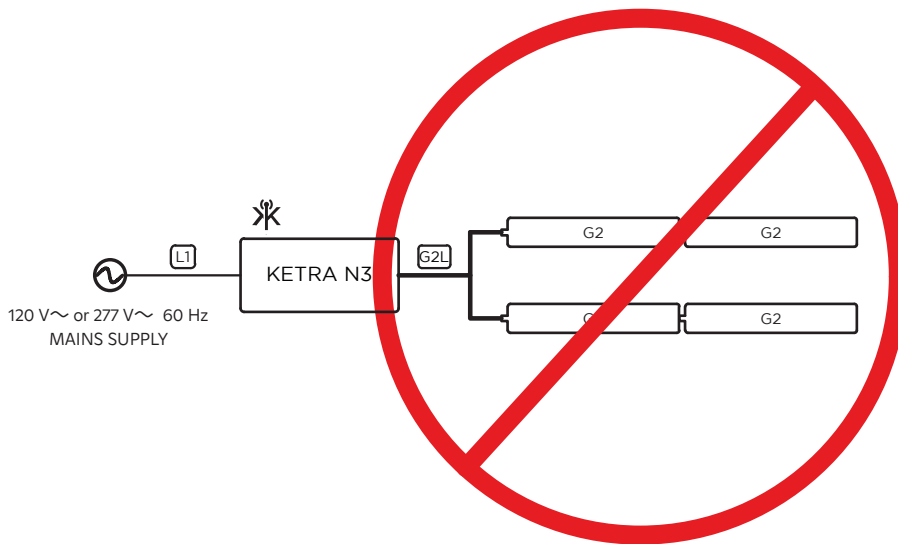
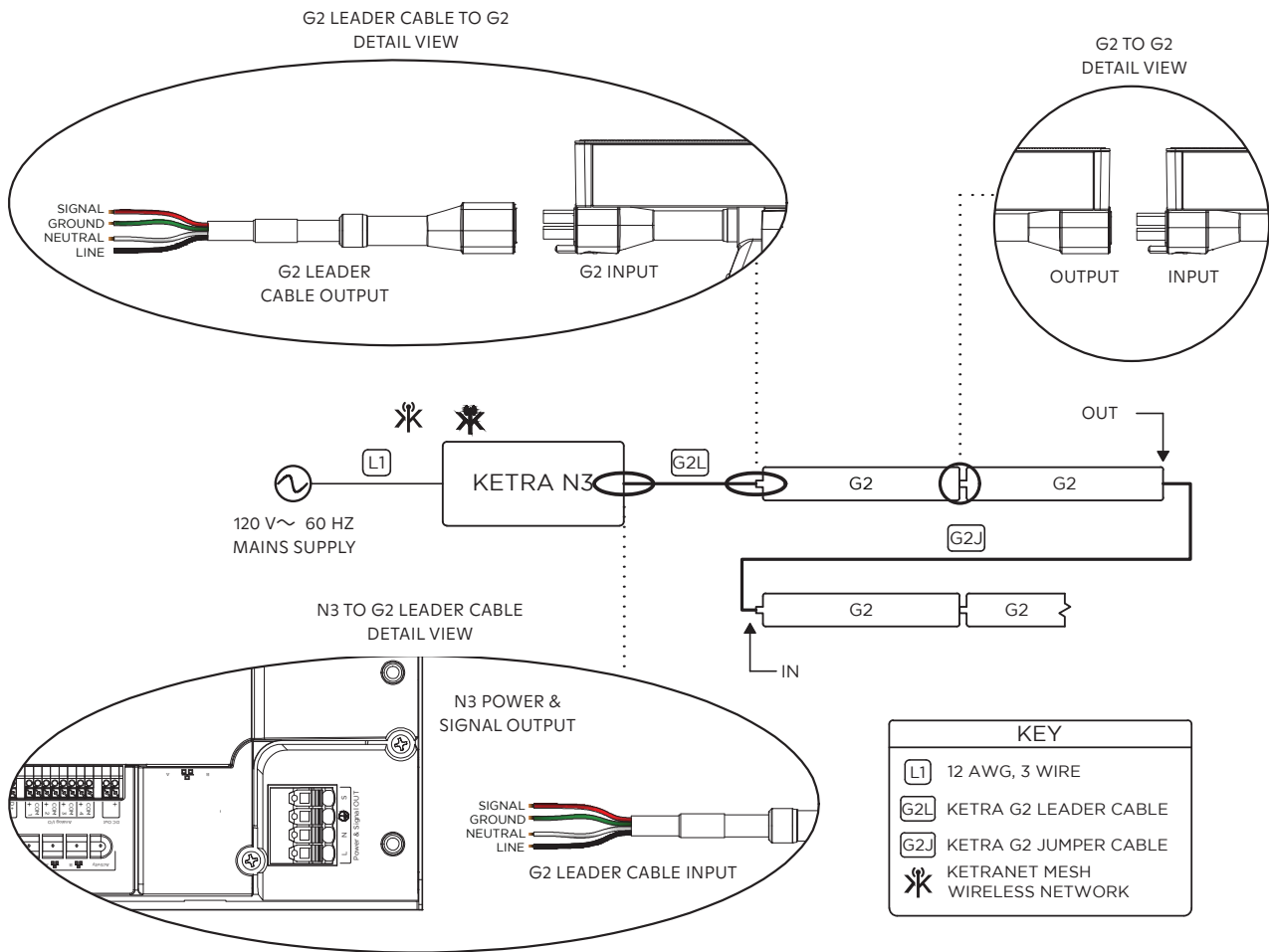

STAR TOPOLOGIES ARE NOT SUPPORTED

DIAGNOSTIC REPORTING

Prior to commissioning in Design Studio, Ketra's G2 Linear should power on to a default white state. If it powers on to some other color, that means there is a problem in the installation conditions. See the table below for each color's meaning.

Color	Condition	Correction
Red	Low input voltage on the power line	Ensure that the input voltage is 120 V~ or 277 V~, + or - 10%
Magenta	Signaling wire connection not detected	Cut power and reconnect the red conductor of the leader cable to the N3's "S" port
Red-Green-Blue Pattern	Fair wireless connectivity	Ensure that the D3 is not in a metal enclosure and that there are no significant obstructions between the D3 and other Ketra devices.
Red-Green Pattern*	Line and neutral wiring switched	Cut power, and reverse line and neutral wiring
Yellow	Multiple runs of G2 detected	Cut power and disconnect all but one run of G2. Only one run can be connected to a satellite
Turquoise	More than 40 G2 detected	Remove the turquoise linears and reboot the satellite
Green	More than 100 ft (30.48 m) run length detected (including cables and fixtures)	Remove excess cabling and/or fixtures, and reboot the satellite
Dark Blue		

* for product ordered in 2019

G2 ALIGNMENT TRACK - G2TRKZP48

Note: All alignment track measurements are shown in mm.

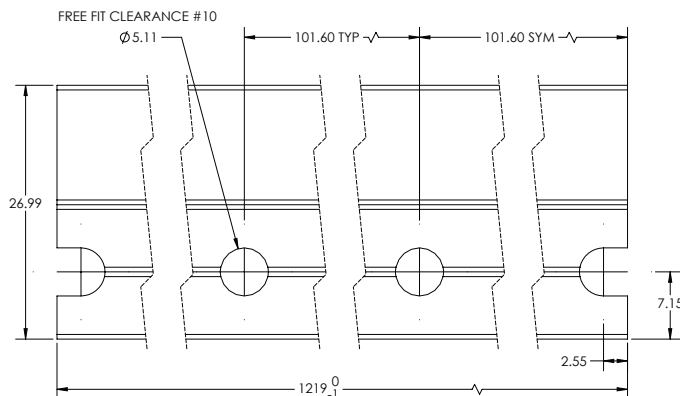
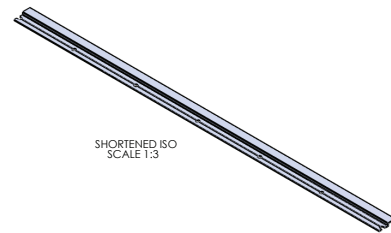
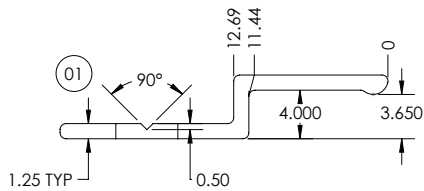

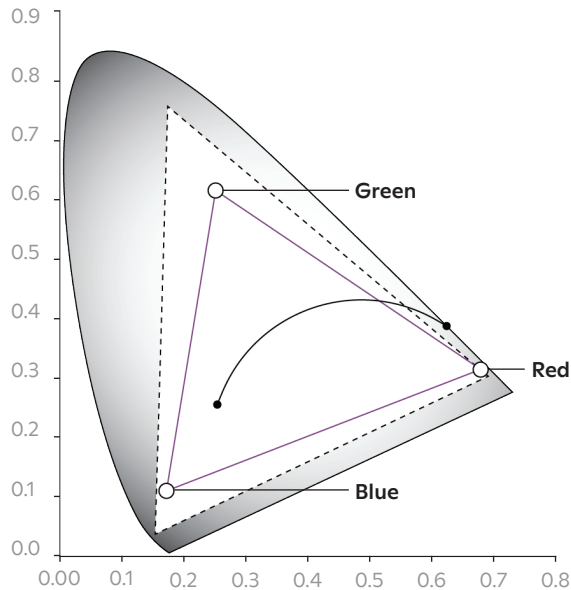
WIDE GAMUT
CIE 1931 Color Chart

Ketra's G2 high output linear accent can easily be commissioned into Lutron HomeWorks or Athena systems. The product can reproduce any color point within the triangle shaped gamut indicated in the chart to the left. With Ketra's Color Lock tool, the color point is maintained to an accuracy of one-step MacAdam Ellipse over the lifetime of the product and across operating temperature range.

— **Color Lock**—Color point is maintained to an accuracy of one-step MacAdam Ellipse over the lifetime of the product and across operating temperature range.

- - - - **Expanded Gamut**—Color calibration is relaxed such that each product produces the most saturated color it is capable of.

G2 General Specifications

Color Point Maintenance: Employ closed loop optical and thermal feedback capable of maintaining color point accuracy at a one-step MacAdam ellipse over product lifetime.

Wireless Capability: LED light source shall have an integrated wireless control on board.

Color Rendering Index (CRI): Capable of CRI greater than 90 at any point along the Black Body Curve from 2,700K to 5,000K.

Single Source Multi-Dye Emitter Design: Employ a single source multi-dye emitter consisting of both monochromatic and phosphor converted blue LED dye.

LED Estimated Useful Life: Minimum of 50,000 hours at 70 percent lumen maintenance, calculated based on IES LM-80 test data.

Warranty: Ketra's light source is warrantied to be free from material defects in material and workmanship for five (5) years or 25,000 hours from date of shipment, whichever is less.

Lighting System Capable of the Following Dimming Functionality:

1. Automatically mimicking natural daylight by shifting Correlated Color Temperature (CCT) and intensity based on time-of-day.
2. Shifting from high CCT at high intensity to low CCT at low intensity, mimicking dimming curve of an incandescent lamp.
3. Changing intensity while maintaining full color spectrum or CCT.
4. Changing full color spectrum or CCT while maintaining intensity.

Spectral Power Distribution Manipulation: Light system capable of manipulating the Spectral Power Distribution (SPD) by automatically adjusting distributions of color intensity while maintaining the same Correlated Color Temperature (CCT).

Dimming Range: Dimmable from 100 to 0.1 percent measured luminous flux.

Color Point Range: Single light source capable of producing 16.7 million colors and white from 1,400K to 10,000K Correlated Color Temperature (CCT).